

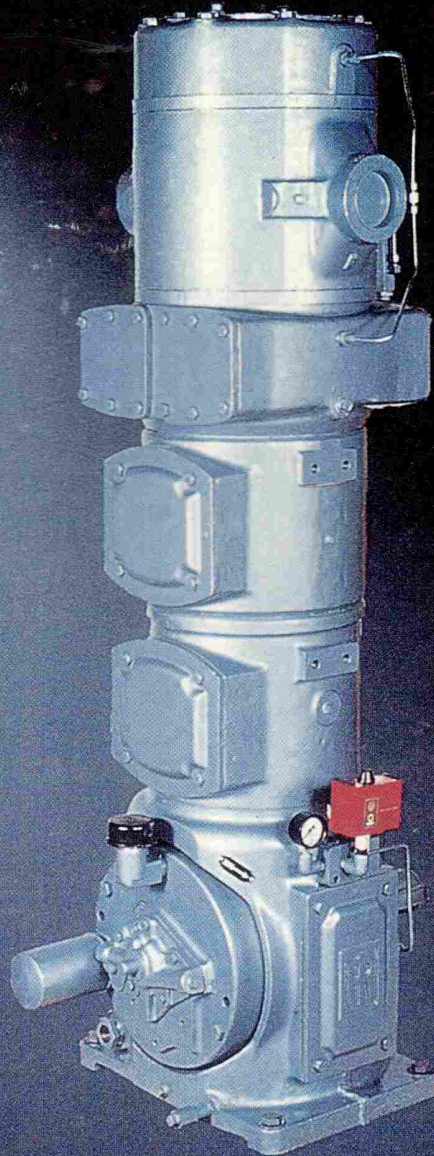

Ingersoll Rand

ESV/ESH Reciprocating, Water-Cooled, Air Compressors

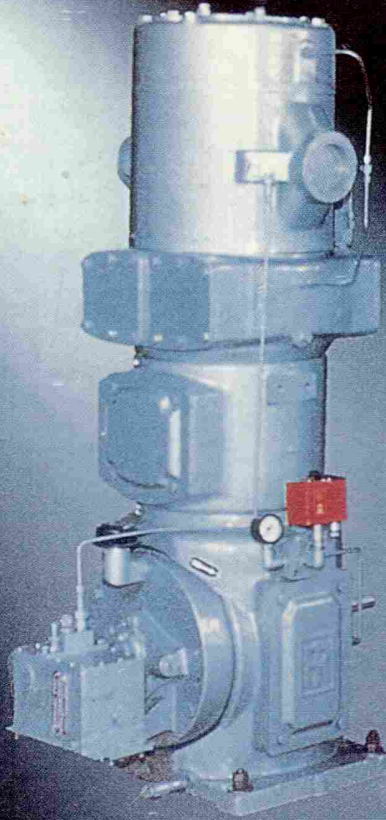

Ingersoll Rand

AIR SOLUTIONS

Sectional view of ESV air compressor

Full floating, self adjusting packing rings

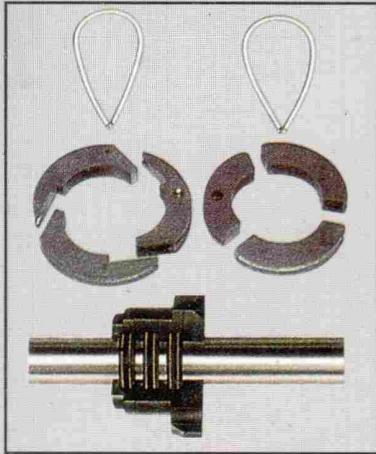

Rectangular, patented, air-cushioned channel valve with free air unloader

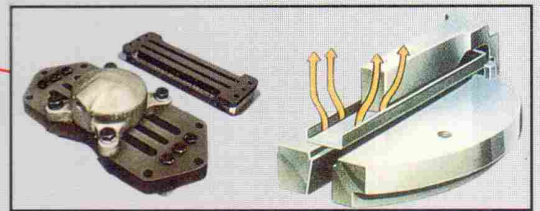

Die forged connecting rod, "split-bolting" type, with rifle drilled oil passage



Crosshead, pin & bearing



Die forged balanced crankshaft, with rifle drilled oil passage

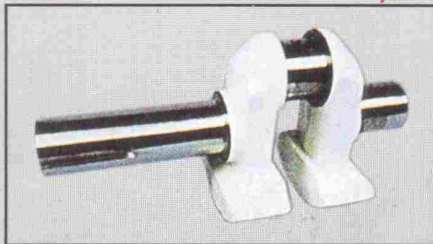

Bearings float in pressurized oil layers. Oil circulated by an internal gear pump driven through a pin attached to crankshaft

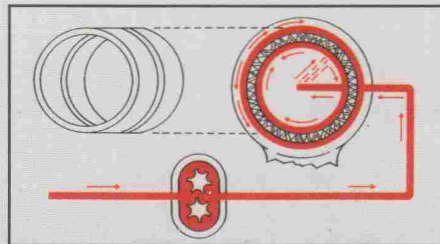

Full floating bearings



Sectional view of NL design

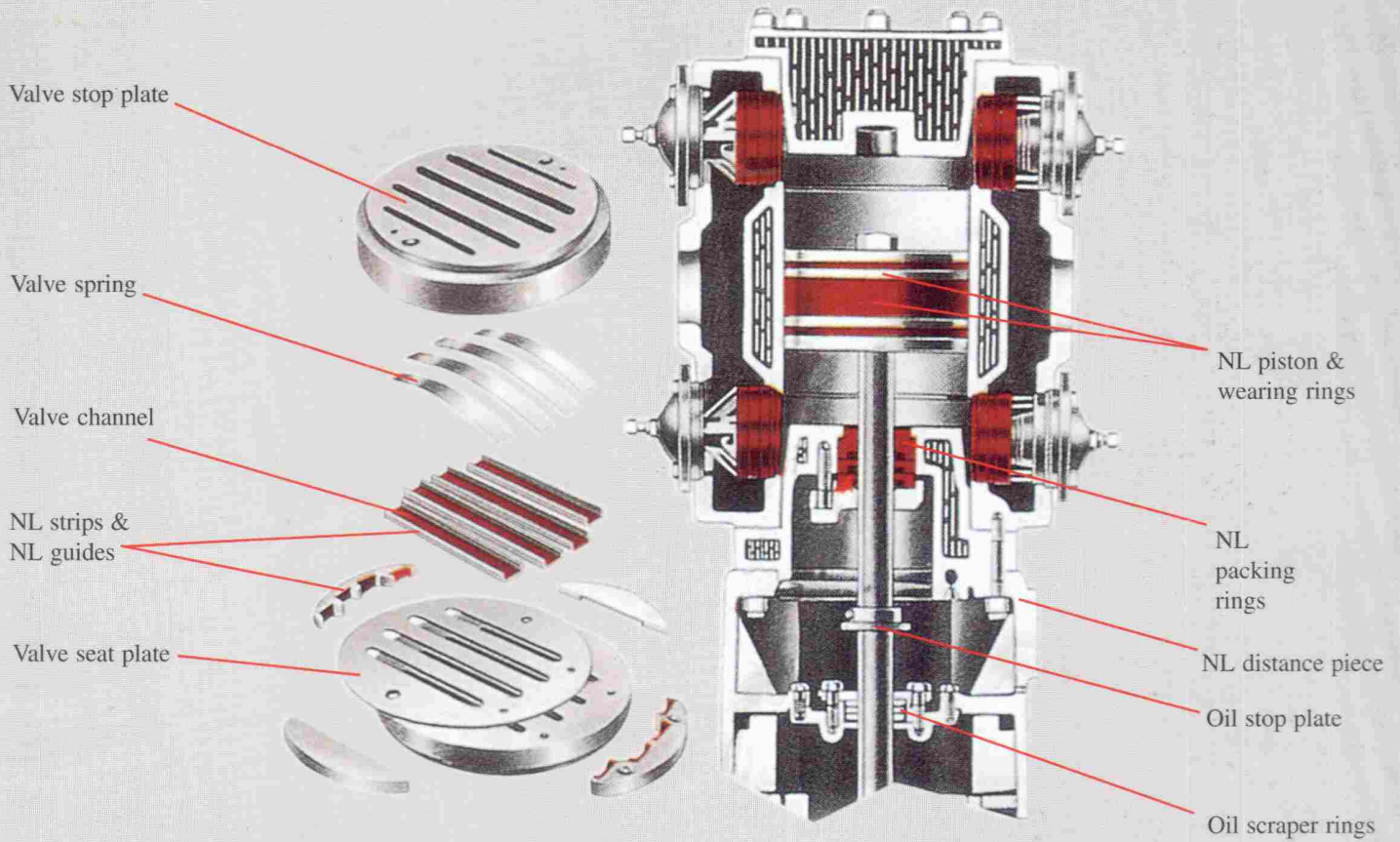

Performance, Weights and Dimensions

ESV Range	Piston Displacement		Speed rpm	Working Pressure		Dimensions (mm)				Weight kgs
	m ³ /min	cfm		kg/cm ² g	psig	Length	Width	Height Lub	Height NL	
7 x 5	4.65	164	750	8.80	125	524	560	1441	1738	620
8 x 5	6.10	215	750	7.00	100	524	560	1441	1738	681
9.5 x 5	7.78	274	675	4.20	60	572	560	1441	1738	718
8 x 7	7.36	260	650	9.50	135	524	730	1675	2023	840
9 x 7	9.33	330	650	7.70	110	572	730	1675	2023	840
11 x 7	14.10	498	650	7.70	100	632	730	1900	2249	1354
ESH Range										
12 x 7	16.74	546	600	3.15	45	2164	730	1009	1009	1396
14 x 7	21.07	744	600	2.45	35	2204	730	1132	1131	1633
16 x 7	27.55	973	600	1.40	20	2204	730	1265	1265	1750

ALWAYS USE GENUINE SPARES FOR BEST PERFORMANCE



More Than Air. Answers.

Ingersoll-Rand air compressors are not designed, intended or approved for breathing air. Compressed air should not be used for breathing air applications unless treated in accordance with all applicable codes and regulations.

Nothing contained in this brochure is intended to extend any warranty or representation, expressed or implied, regarding the products described herein. Any such warranties or other terms and conditions of sale shall be in accordance with Ingersoll-Rand's standard terms and conditions of sale for such products which are available upon request.

Product improvement is a continuing goal at Ingersoll-Rand. Designs and specifications are subject to change without notice or obligation.

Your nearest contact:

Ingersoll-Rand (India) Limited
G.I.D.C Estate, Naroda,
Ahmedabad - 382 330.
Tel.: (079) 2820323
Fax: (079) 2821003